

### Standard / Ottomans / Armless

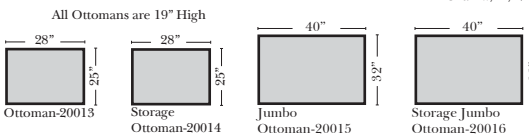

### 2-Piece Curve Sectional

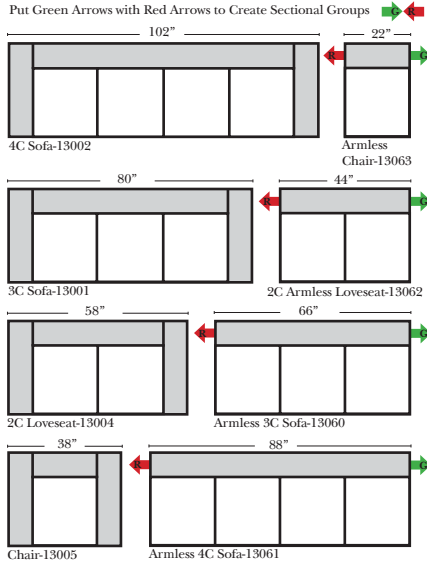
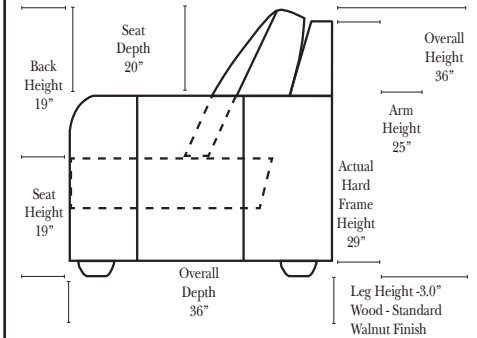
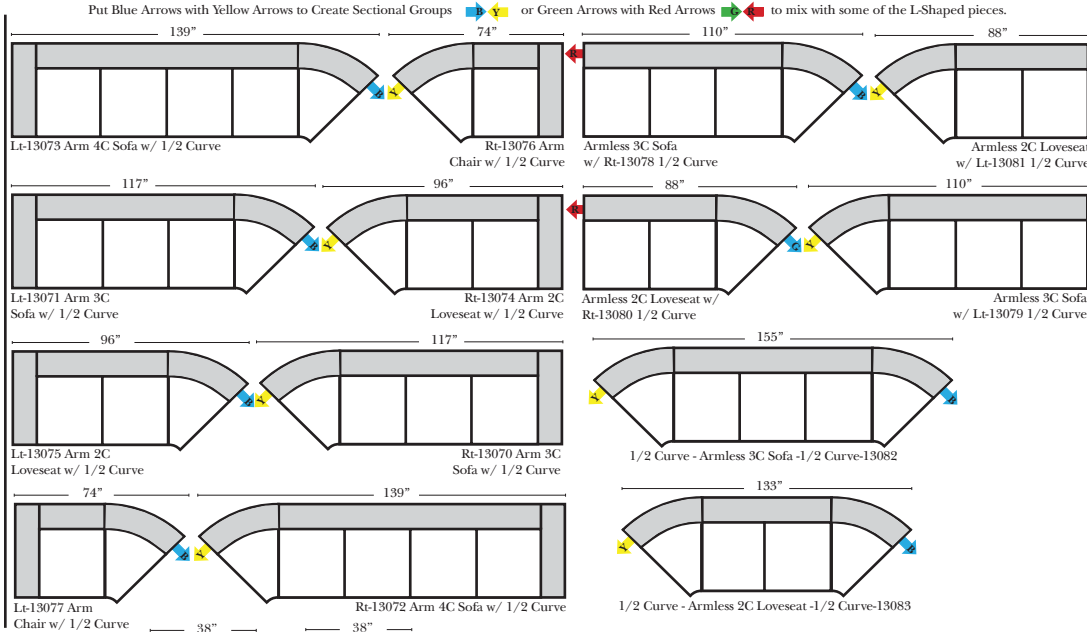

### Standard & Options

#### Standard:

- Available in Full & Top Grain Leathers
- Available in Luxury Fabrics
- All Hardwood Frames
- Nail Heads (where indicated)
- Wood Leg Finish (Standard is Walnut)

#### Options: (No Additional Charge)

- No. 33 Firm Foam
- Wood Leg Finish (Available in Cherry, Chocolate, Espresso, Honey Oak, & Shadow)
- Arm Pillows (will be included, ONLY when a style is ordered with fabric seat AND back cushions)

#### Options: (Additional Charges Apply)

- Down Seats & Down Backs
- Upholstered Swivel Base(2 arm Chair Only)

#### Sleeper Options: (Additional Charges Apply)

- Full Sleeper available w/Standard Mattress
- 5" Memory Foam Mattress: Full
- Air Dream Coil Mattress: Full Only

### L-Shape / 90 Degree Sectional

(All 4 seat items ship as one piece if stationary, two pieces if motion installed)

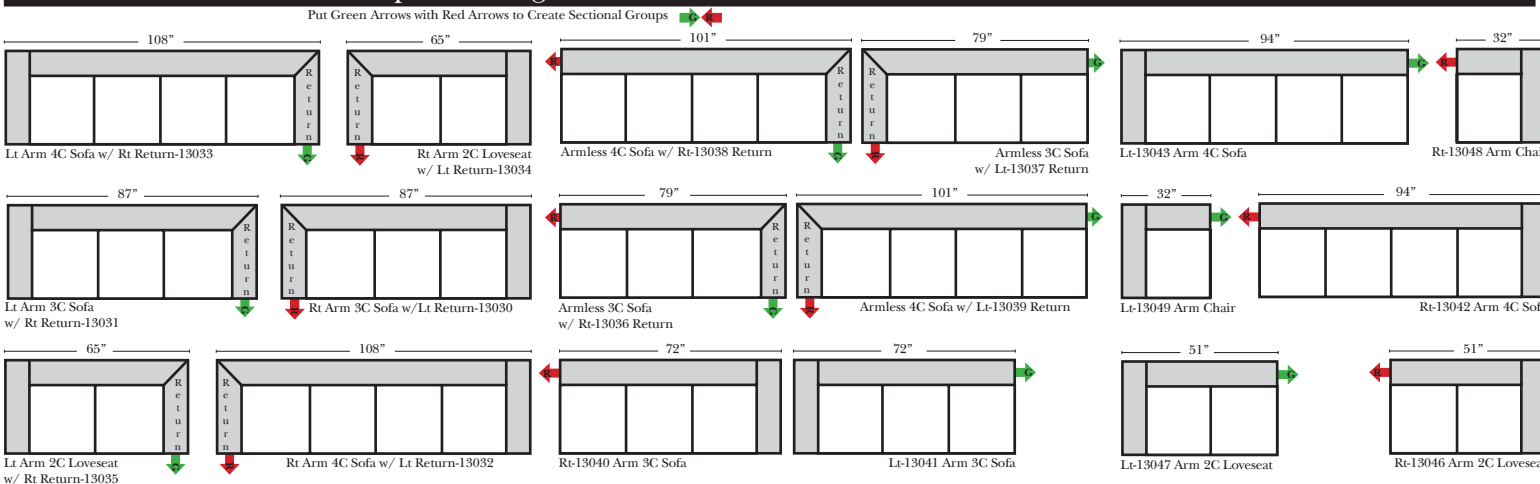

#### Note:

All Dimensions are approximate, if accuracy is crucial, please contact us for validation of the dimensions shown. However, a 1" to 2" variance can still apply due to foam and upholstery.

## Bumper / Return Chaise & Conversation Sofas

Put Green Arrows with Red Arrows to Create Sectional Groups  
Put Orange Arrows with Tan Arrows to Create Sectional Groups

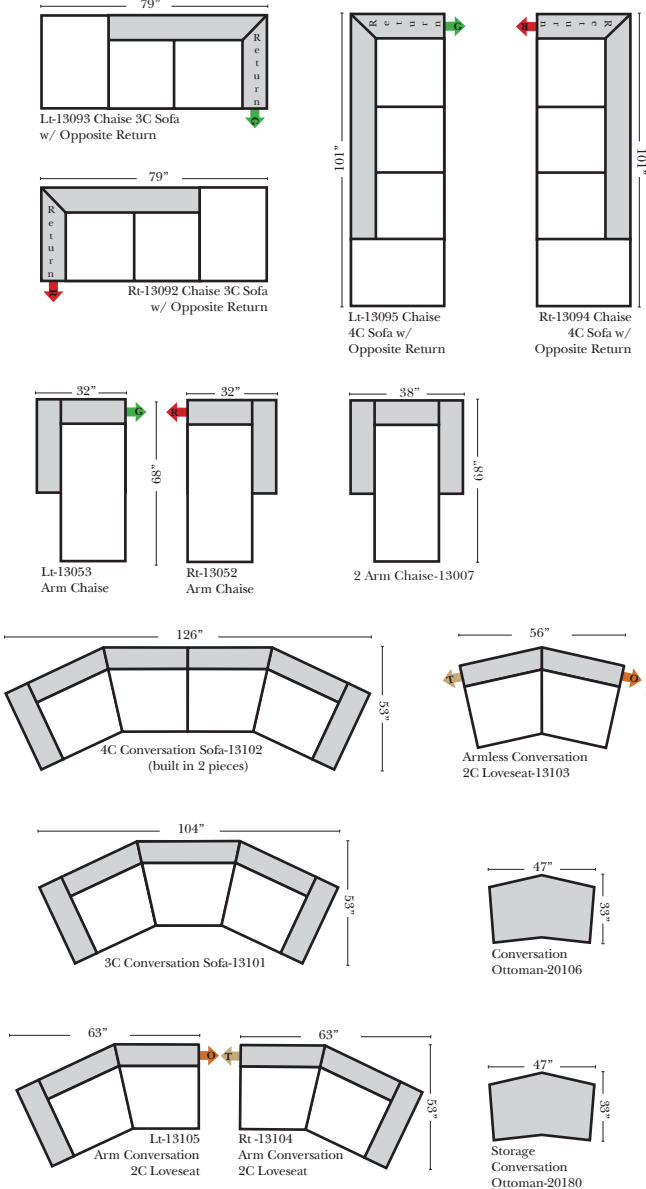

## Sleepers

Put Green Arrows with Red Arrows to Create Sectional Groups  
Put Blue Arrows with Yellow Arrows to Create Sectional Groups

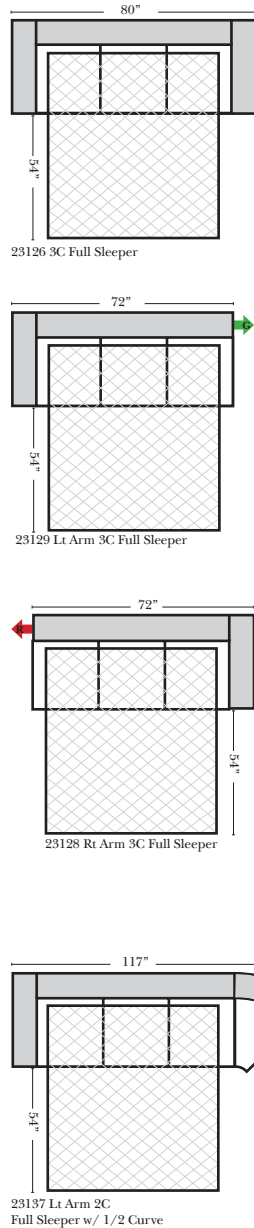

## Suggested Configurations

v.05.10.18

The Suggested Configurations below are only a sample of what the imagination can create, please enjoy creating the configuration that fits your lifestyle, using the ideas below and from the items on the opposite page.

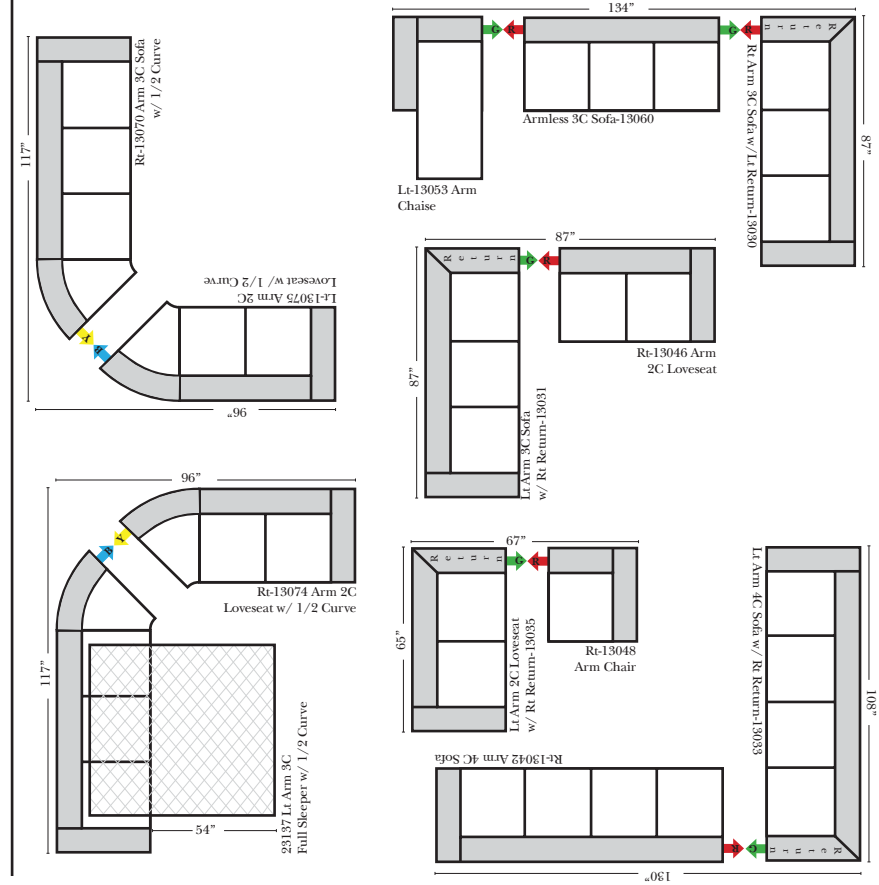

## Sleepers (Cont.)

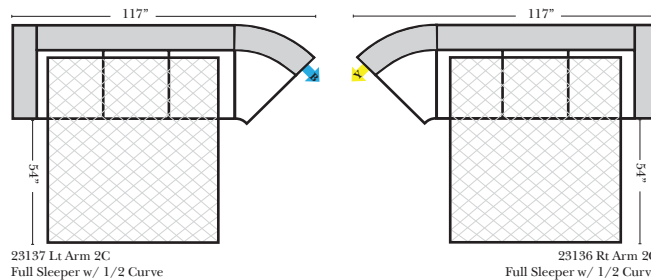

### Standard / Ottomans / Armless

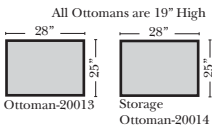
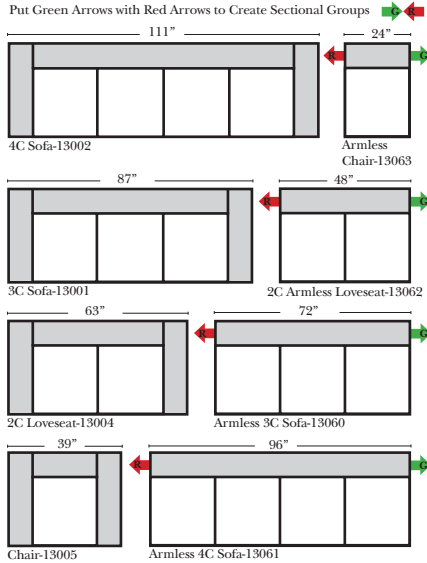

### 2-Piece Curve Sectional

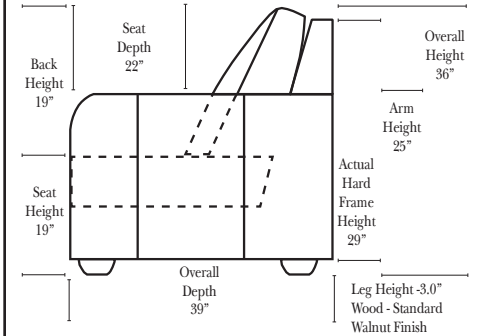
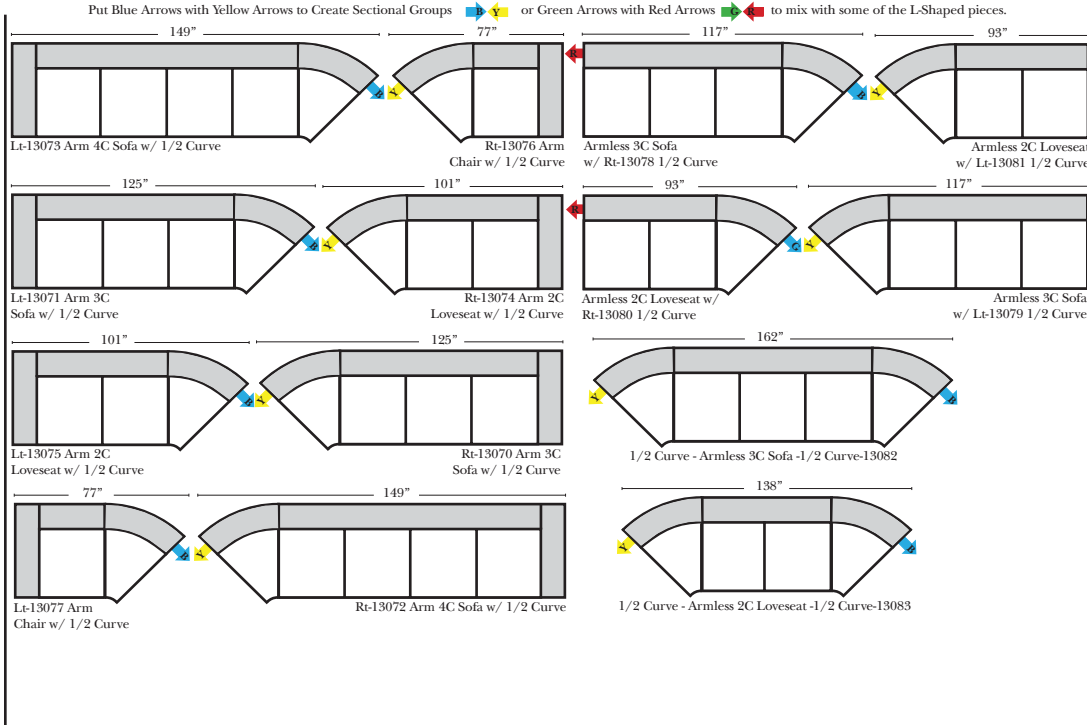

### Standard & Options

#### Standard:

- Available in Full & Top Grain Leathers
- Available in Luxury Fabrics
- All Hardwood Frames
- Nail Heads (where indicated)
- Wood Leg Finish (Standard is Walnut)

#### Options: (No Additional Charge)

- No. 33 Firm Foam
- Wood Leg Finish (Available in Cherry, Chocolate, Espresso, Honey Oak, & Shadow)
- Arm Pillows (will be included, ONLY when a style is ordered with fabric seat AND back cushions)

#### Options: (Additional Charges Apply)

- Down Seats & Down Backs
- Upholstered Swivel Base(2 arm Chair Only)

#### Sleeper Options: (Additional Charges Apply)

- Queen Sleeper available w/Standard Mattress
- Twin Sleeper available w/Standard Mattress
- 5" Memory Foam Mattress: Queen / Twin
- Air Dream Coil Mattress: Queen Only - (No Twin)
- Hideaway Air Mattress: Queen Only (Shipped in a Separate Box)

### L-Shape / 90 Degree Sectional

(All 4 seat items ship as one piece if stationary, two pieces if motion installed)

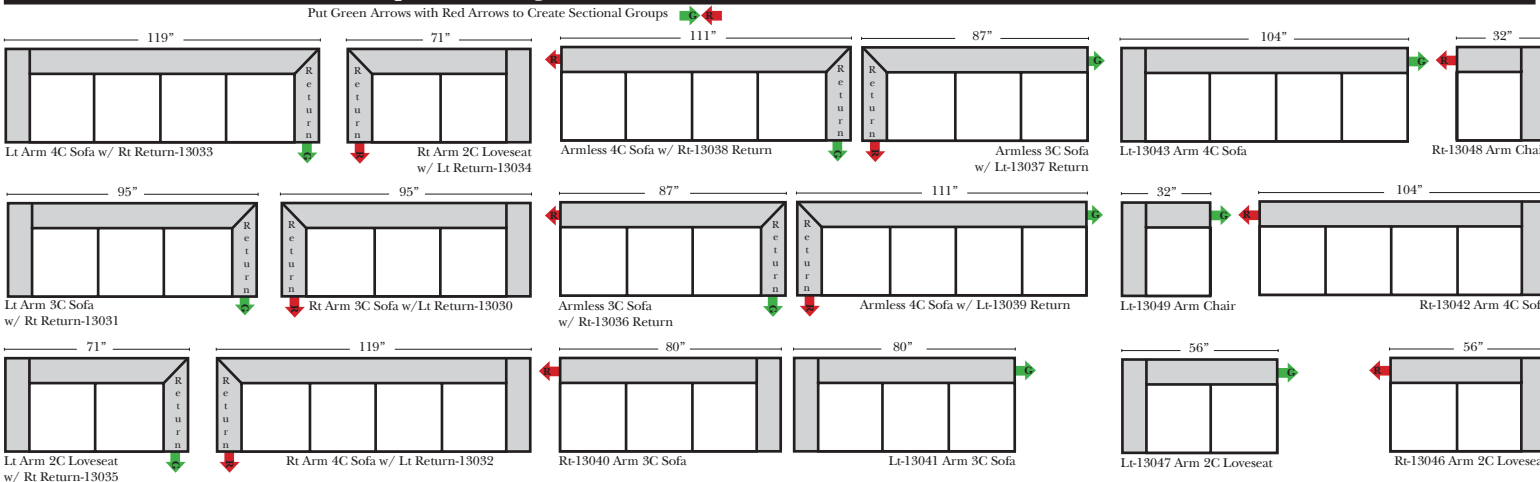

#### Note:

All Dimensions are approximate, if accuracy is crucial, please contact us for validation of the dimensions shown. However, a 1" to 2" variance can still apply due to foam and upholstery.

### Bumper / Return Chaise & Conversation Sofas

Put Green Arrows with Red Arrows to Create Sectional Groups  
Put Orange Arrows with Tan Arrows to Create Sectional Groups

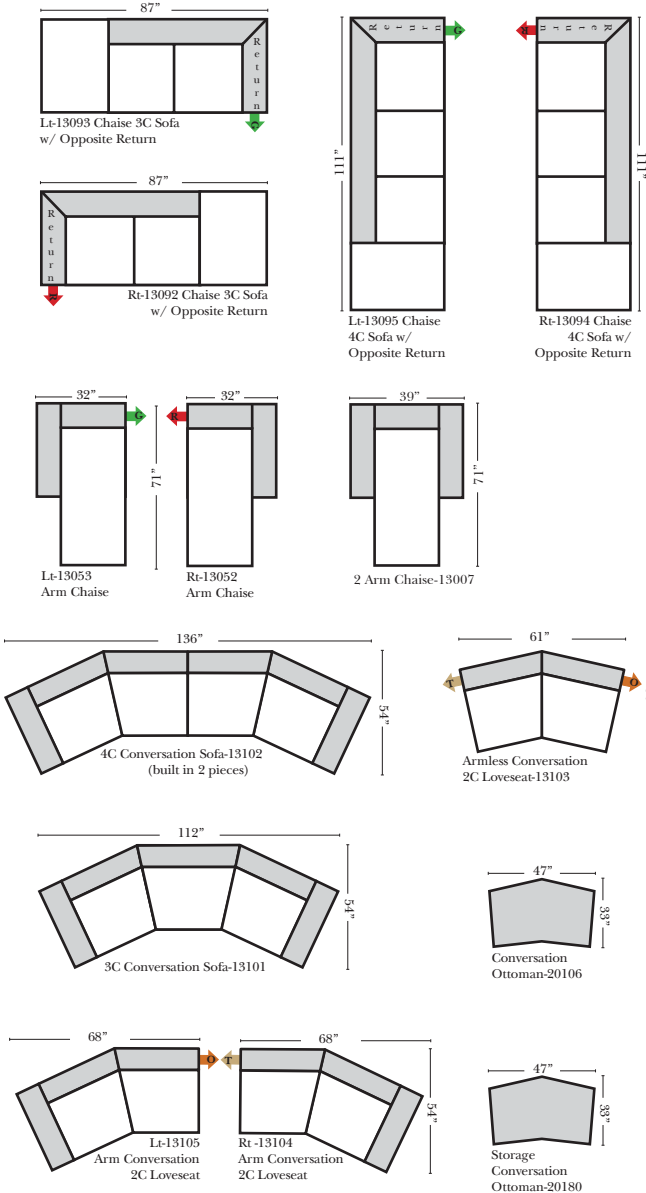

### Sleepers

Put Green Arrows with Red Arrows to Create Sectional Groups  
Put Blue Arrows with Yellow Arrows to Create Sectional Groups

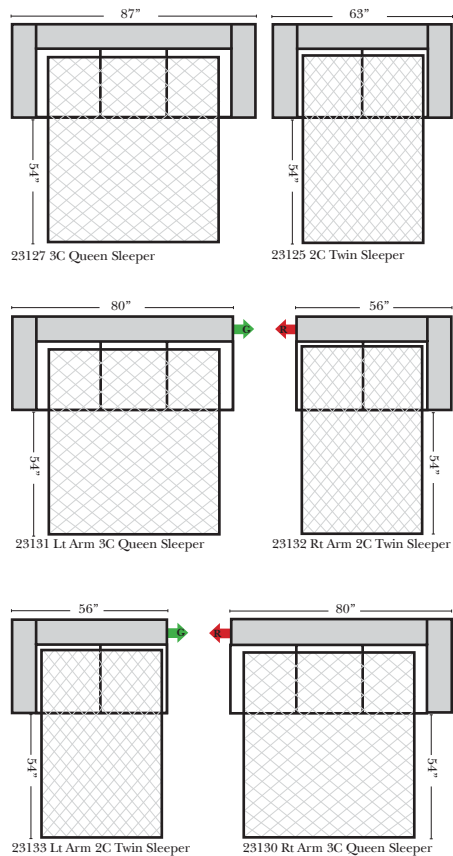

### Suggested Configurations

v.05.10.18

The Suggested Configurations below are only a sample of what the imagination can create, please enjoy creating the configuration that fits your lifestyle, using the ideas below and from the items on the opposite page.

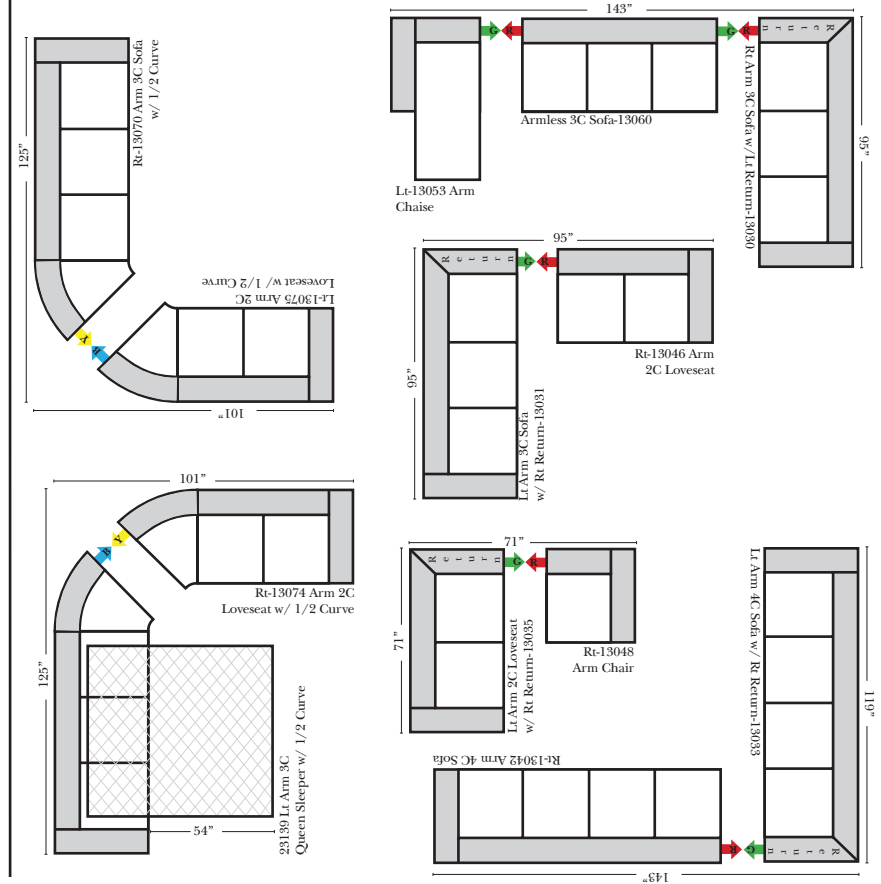

### Sleepers (Cont.)

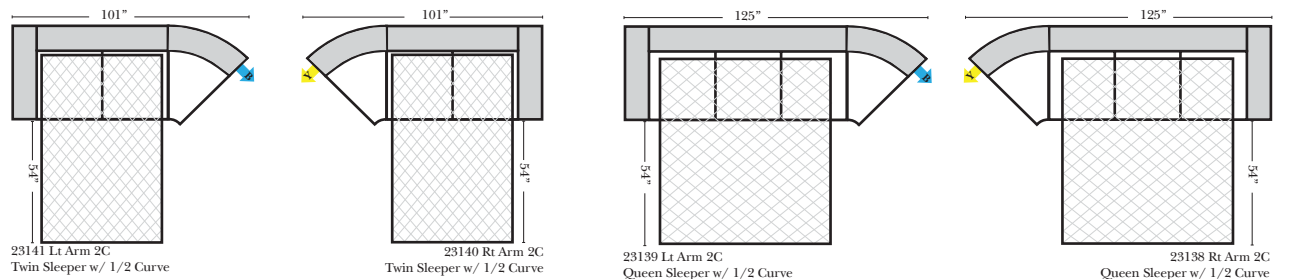

### Standard / Ottomans / Armless

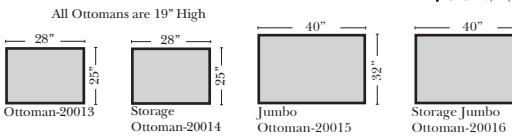
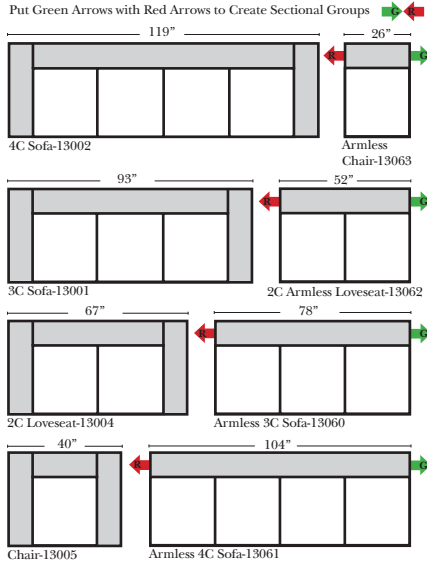

### 2-Piece Curve Sectional

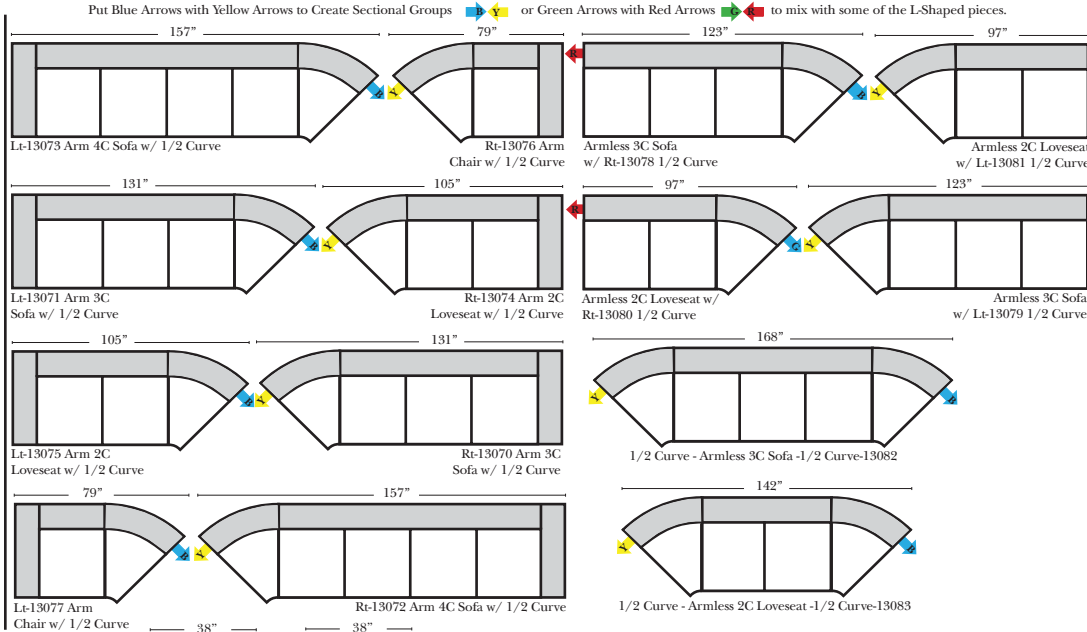

v.05.10.18

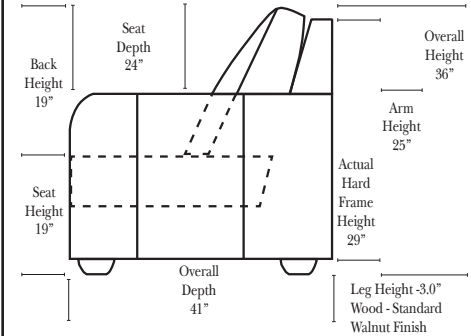

### Standard & Options

#### Standard:

- Available in Full & Top Grain Leathers
- Available in Luxury Fabrics
- All Hardwood Frames
- Nail Heads (where indicated)
- Wood Leg Finish (Standard is Walnut)

#### Options: (No Additional Charge)

- No. 33 Firm Foam
- Wood Leg Finish (Available in Cherry, Chocolate, Espresso, Honey Oak, & Shadow)
- Arm Pillows (will be included, ONLY when a style is ordered with fabric seat AND back cushions)

#### Options: (Additional Charges Apply)

- Down Seats & Down Backs
- Upholstered Swivel Base(2 arm Chair Only)

#### Sleeper Options: (Additional Charges Apply)

- Queen Sleeper available w/Standard Mattress
- Twin Sleeper available w/Standard Mattress
- 5" Memory Foam Mattress: Queen / Twin
- Air Dream Coil Mattress: Queen Only - (No Twin)
- Hideaway Air Mattress: Queen Only (Shipped in a Separate Box)

### L-Shape / 90 Degree Sectional

(All 4 seat items ship as one piece if stationary, two pieces if motion installed)

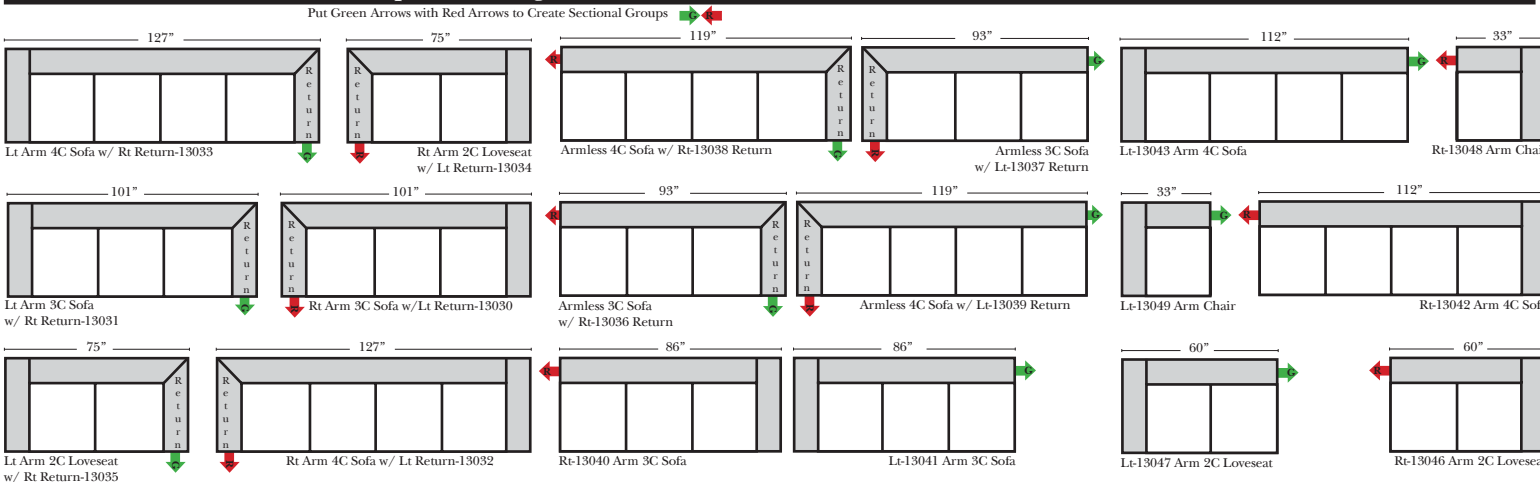

#### Note:

All Dimensions are approximate, if accuracy is crucial, please contact us for validation of the dimensions shown. However, a 1" to 2" variance can still apply due to foam and upholstery.

### Bumper / Return Chaise & Conversation Sofas

Put Green Arrows with Red Arrows to Create Sectional Groups  
Put Orange Arrows with Tan Arrows to Create Sectional Groups

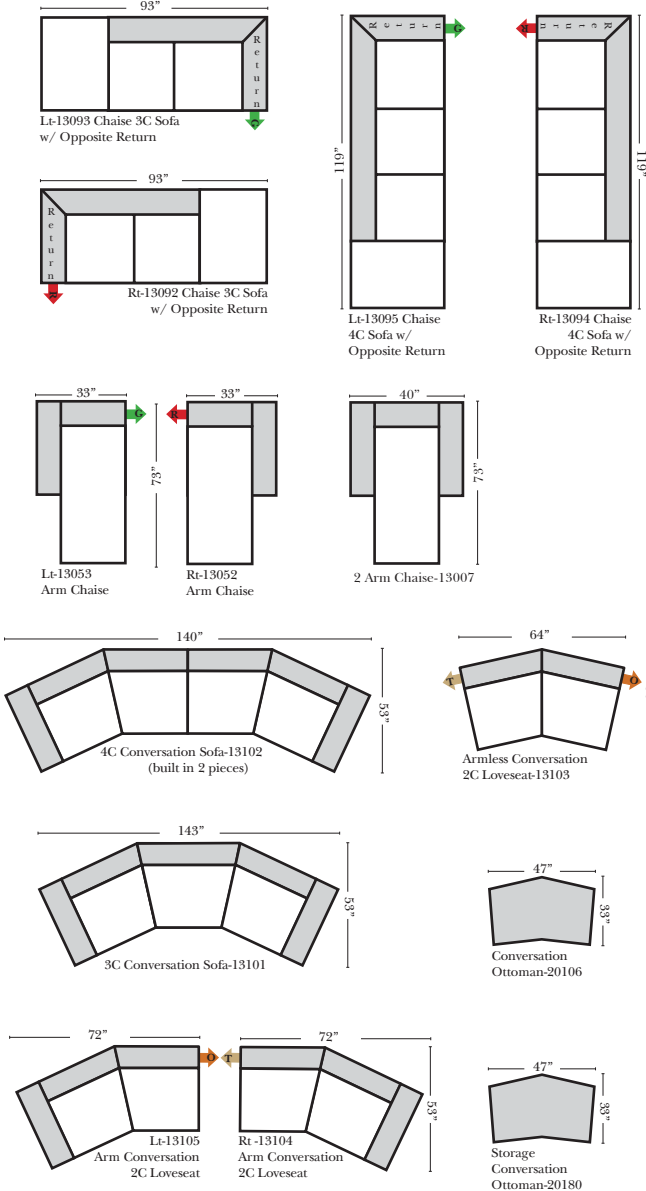

### Sleepers

Put Green Arrows with Red Arrows to Create Sectional Groups  
Put Blue Arrows with Yellow Arrows to Create Sectional Groups

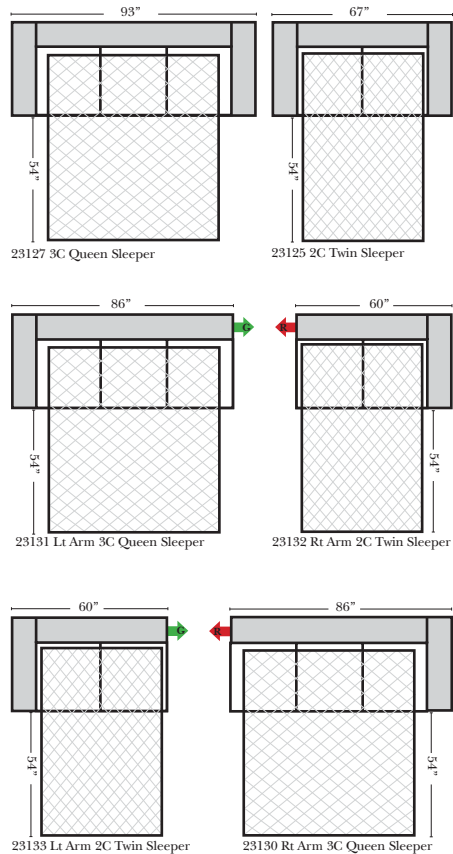

### Suggested Configurations

v.05.10.18

The Suggested Configurations below are only a sample of what the imagination can create, please enjoy creating the configuration that fits your lifestyle, using the ideas below and from the items on the opposite page.

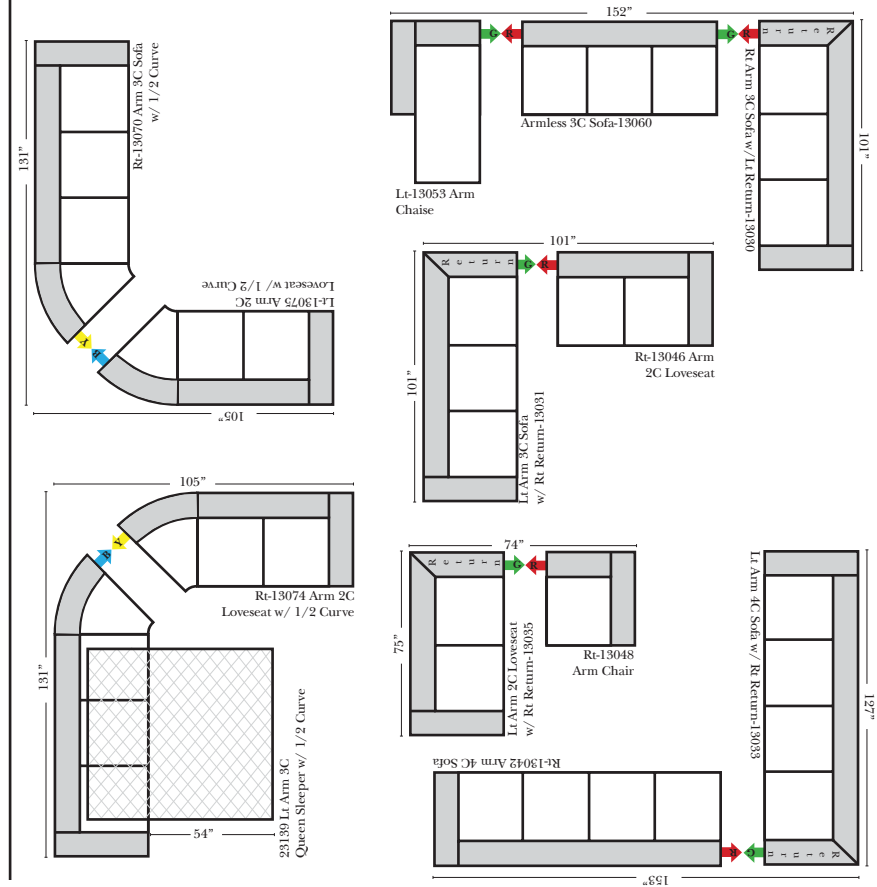

### Sleepers (Cont.)

