

Standard / Armless

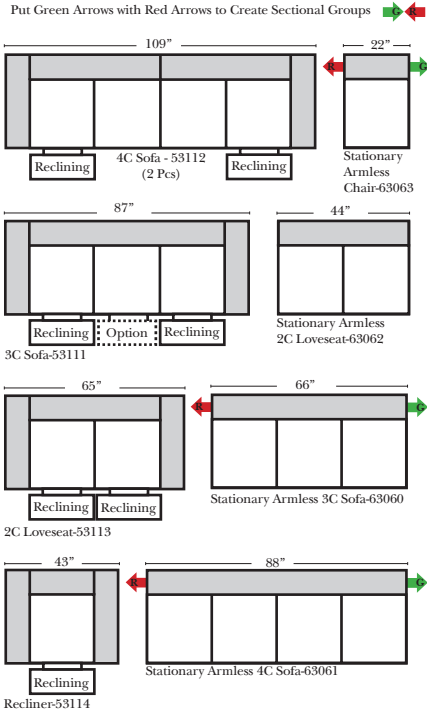

2-Piece Curve Sectional

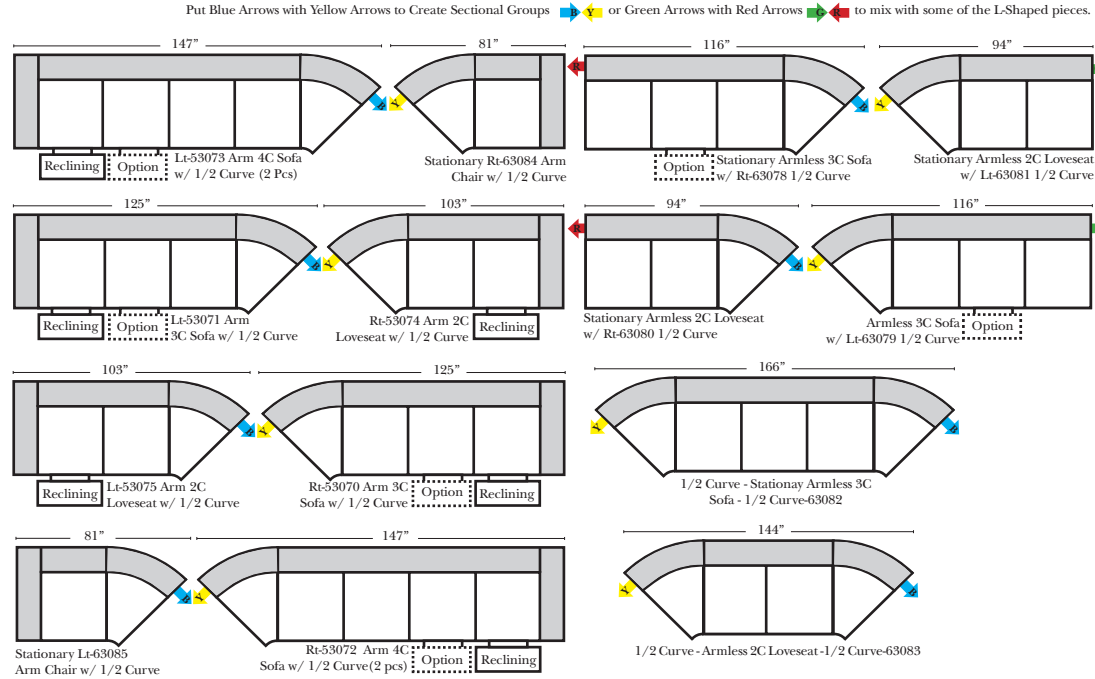

All items on these pages are available as Stationary (Non-Reclining)

90 Degree / L-Shape Sectional

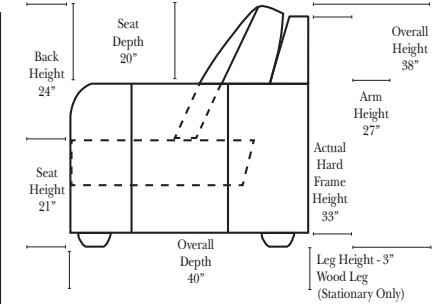
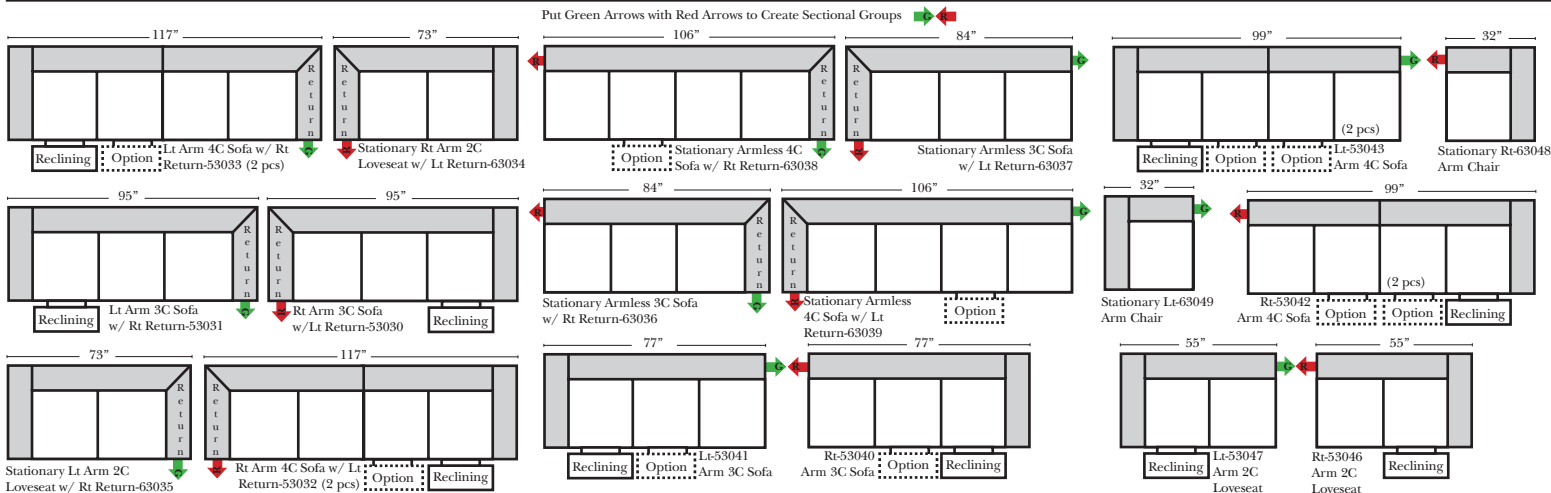

v.11.23.15

Standards & Options

Standard:

- Available in Full & Top Grain Leathers
- Available in Luxury Fabrics
- All Hardwood Frames
- Wood Leg Finish - Walnut Finish (Stationary Only)

Options: (No Additional Charge)

- No. 33 Firm Foam
- Wood Leg - Cherry, Chocolate, Espresso, Honey Oak, Shadow

Options: (Additional Charges Apply)

- Console Table - Standard as Espresso finish (N/C Option is Honey Oak finish)
- Metal Cup Holder (MCH) - Standard Finish is Silver (N/C Option is Black or Hammered Antique Finish) (Available with Motorized Reclining Seats only)
- Electronic Cup Holder (ECH) (Console Arms Only)
- Center Seat Recliner
- Motorized Recliner Mechanism
- Swivel Recliner Base (2 Arm Recliner Only)
- Swivel Glider Mechanism (2 Arm Recliner Only)
- Lift Chair Dual Motor Mechanism (2 Arm Recliner Only)
- Upholstered Swivel Base (2 Arm Recliner Only)
- Motorized 180° Swivel Glider (2 Arm Recliner Only)

Sleeper Options: (Additional charges apply)

- Full Sleeper available w/Standard Mattress
- Deluxe Innerspring Mattress: Full
- Air Dream Coil Mattress: Full Only



Note:

All Dimensions are approximate, if accuracy is crucial, please contact us for validation of the dimensions shown. However, a 1" to 2" variance can still apply due to foam and upholstery.

Bumper / Return Chaise & Conversation Sofas

Put Green Arrows with Red Arrows to Create Sectional Groups
Put Orange Arrows with Tan Arrows to Create Sectional Groups

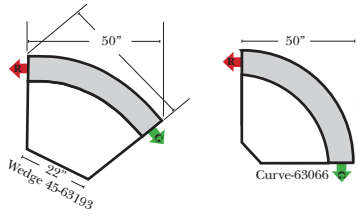
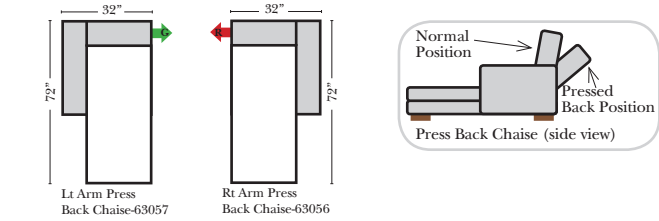

All Ottomans have a height of 19"

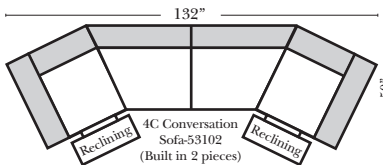
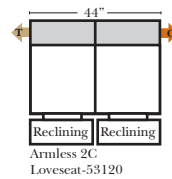
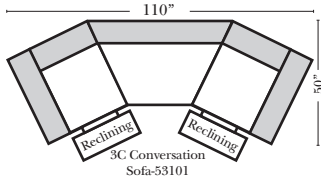
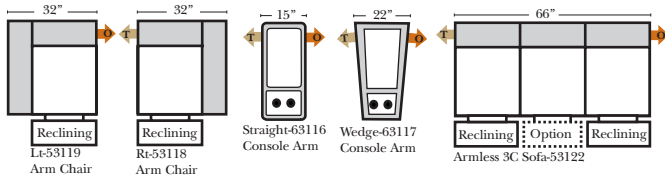
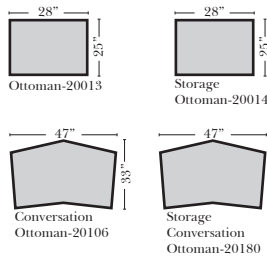

(No other configurations can be put between the 4C Conversation Sofa pieces)

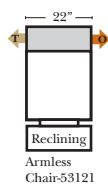

Sleepers

Put Blue Arrows with Yellow Arrows to Create Sectional Groups

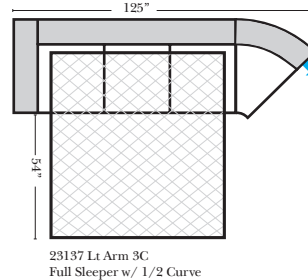
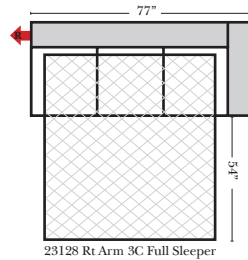
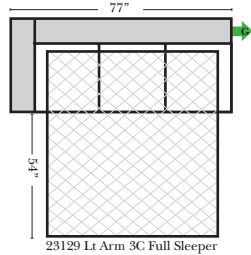
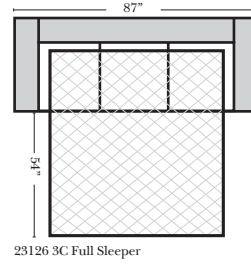

Suggested Configurations

v.11.23.15

The Suggested Configurations below are only a sample of what the imagination can create, please enjoy creating the configuration that fits your lifestyle, using the ideas below and from the items on the opposite page.

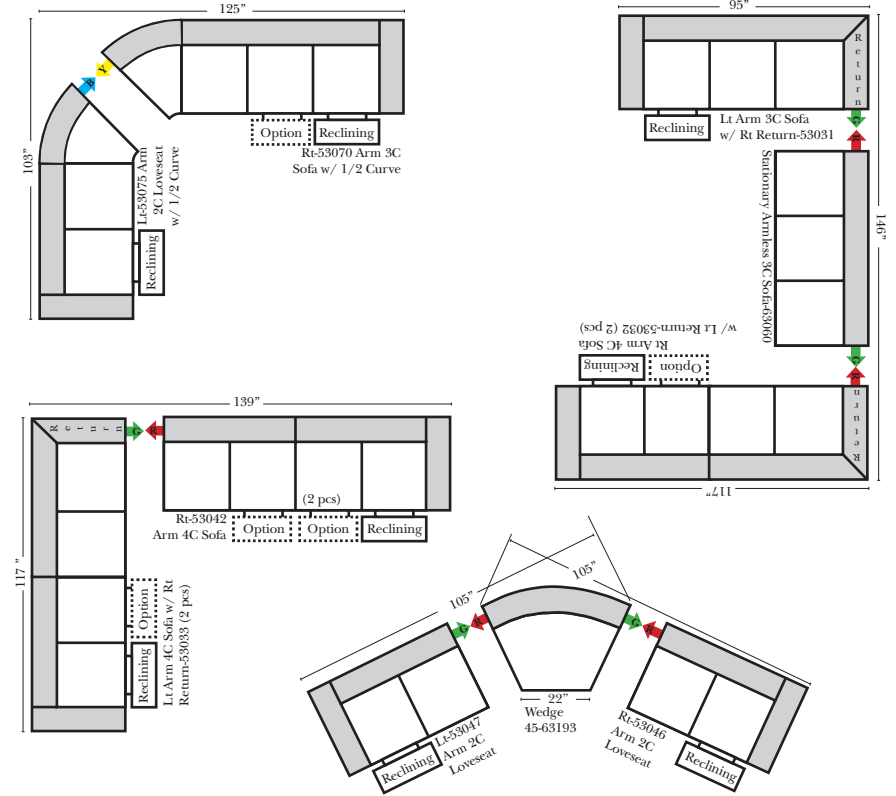

Sleepers (cont.)

