

## Standard, Armless & Ottomans (All 4 seat items ship as one piece if stationary)

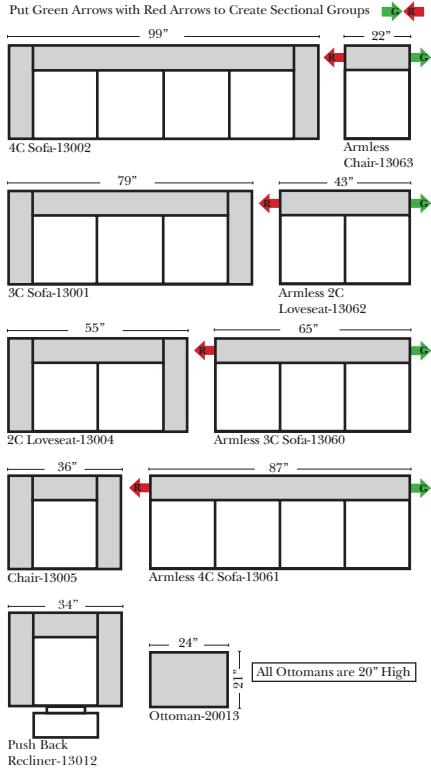

## 2 Piece Curve Sectional & Ottomans

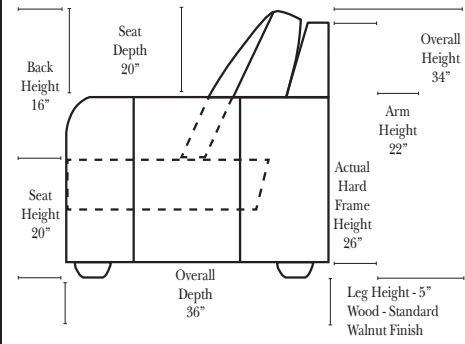
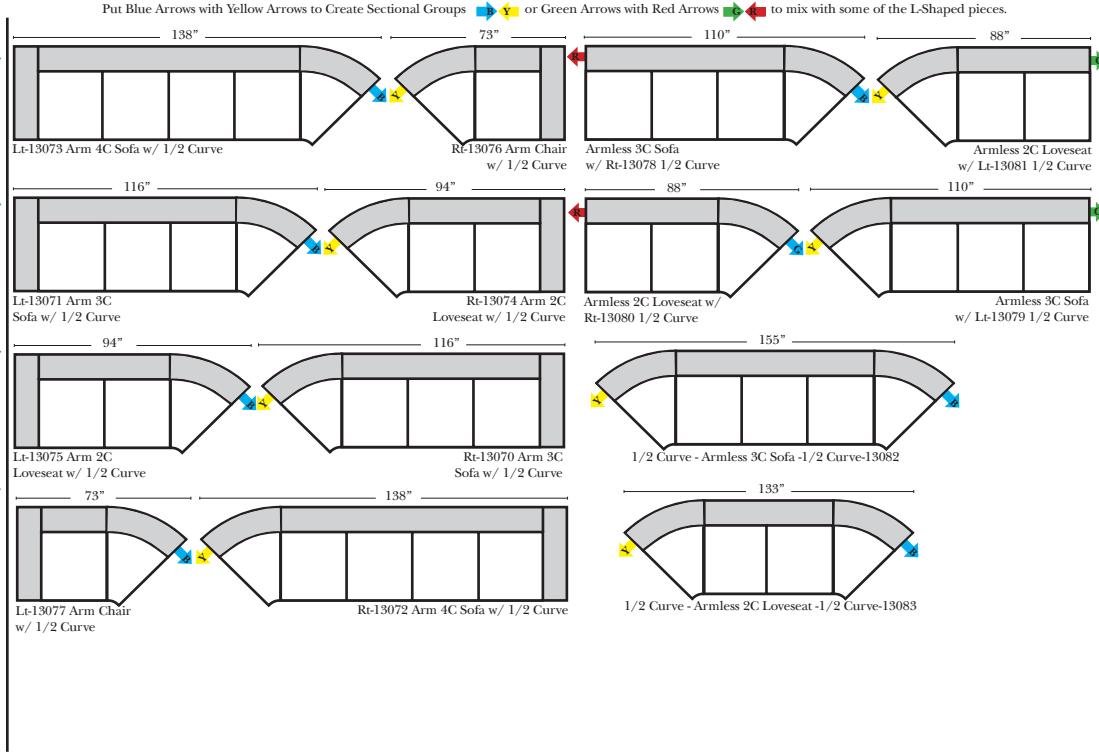

### Standard & Options

#### Standard:

- Available in Full & Top Grain Leathers
- Available in Luxury Fabrics
- All Hardwood Frames
- Wood Leg Finish (Standard is Walnut)

#### Options: (No Additional Charge)

- No. 33 Firm Foam Cushions
- Wood Leg Finish (Available in Cherry, Chocolate, Espresso, Honey Oak, & Shadow)

#### Options: (Additional Charge)

- Down Seats & Down Backs

#### Sleeper Options : (Sleepers not available for this style)

## L-Shape / 90 Degree Sectional

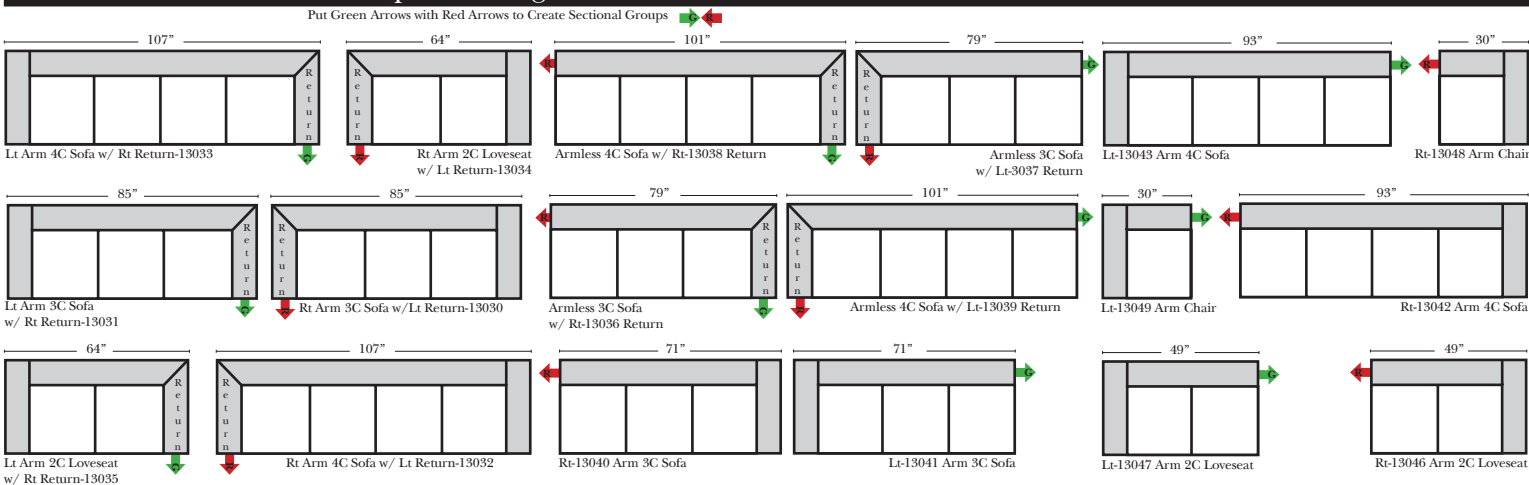

(All 4 seat items ship as one piece if stationary)



#### Note:



All Dimensions are approximate, if accuracy is crucial, please contact us for validation of the dimensions shown. However, a 1" to 2" variance can still apply due to foam and upholstery.

### Chaise & Conversation Sectionals

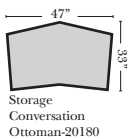
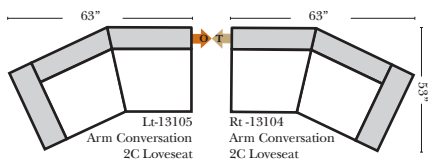
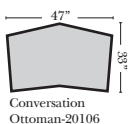
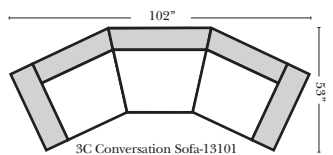
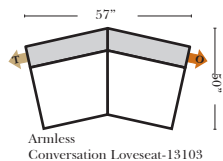
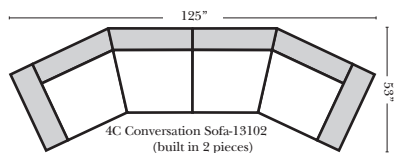
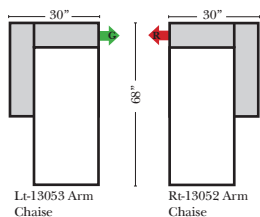
Put Green Arrows with Red Arrows to Create Sectional Groups   
 Put Orange Arrows with Tan Arrows to Create Sectional Groups 



### Sleepers

Put Green Arrows with Red Arrows to Create Sectional Groups   
 Put Blue Arrows with Yellow Arrows to Create Sectional Groups 

Sleepers  
for this style not available  
for this style

### Suggested Configurations

v.10.03.16

The Suggested Configurations below are only a sample of what the imagination can create, please enjoy creating the configuration that fits your lifestyle, using the ideas below and from the items on the opposite page.

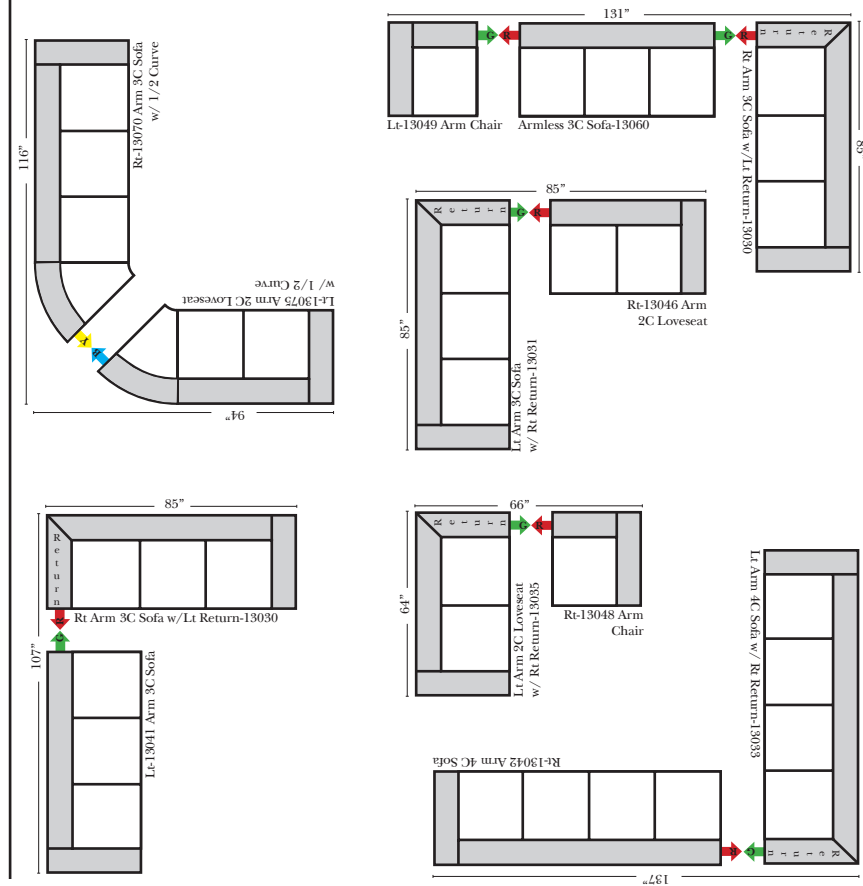

Sleepers (Cont.)