

## Standard, Armless & Ottomans

Put Green Arrows with Red Arrows to Create Sectional Groups

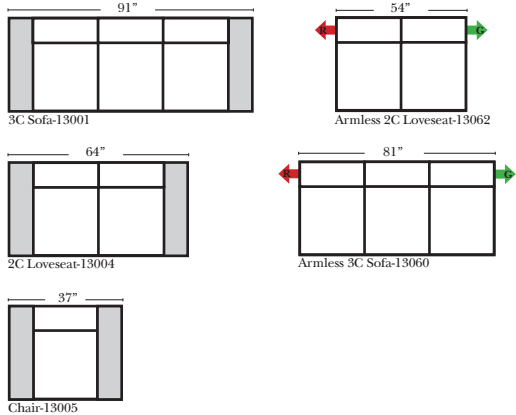

All Ottomans are 18" High

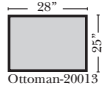

## L-Shape / 90 Degree Sectional

Put Green Arrows with Red Arrows to Create Sectional Groups

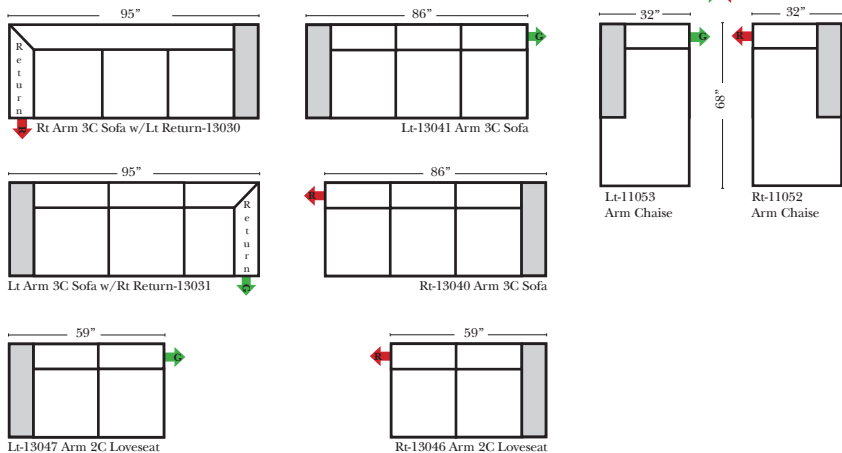

## Suggested Configurations

08/29/2019

The Suggested Configurations below are only a sample of what the imagination can create, please enjoy creating the configuration that fits your lifestyle, using the ideas below and from the items on the opposite page.

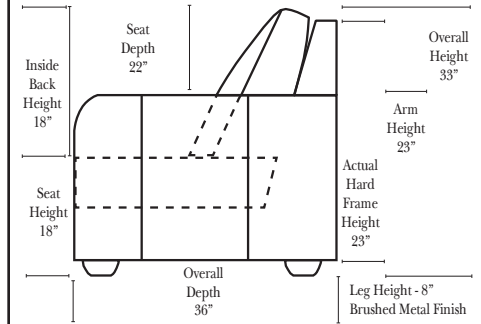
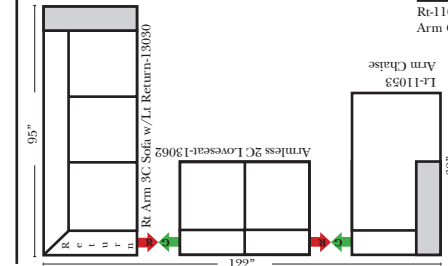
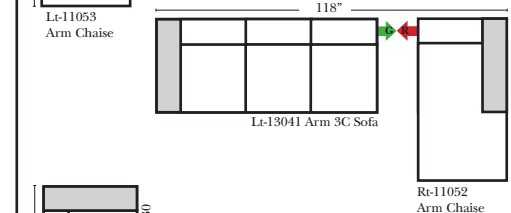
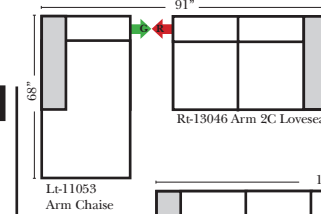
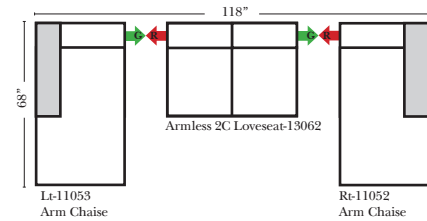
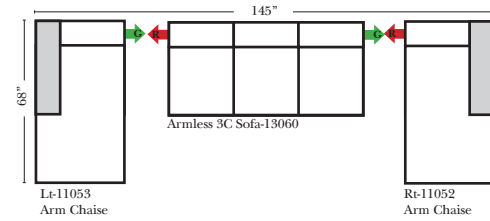
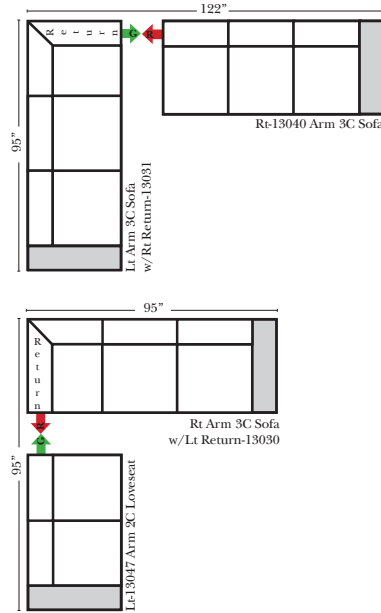

## Specifications & Options

### Standard:

- Available in Full & Top Grain Leathers
- Available in Luxury Fabrics
- All Hardwood Frames
- Leg Finish - Brushed Metal

### Options Available with No Additional Charge:

- No. 33 Firm Foam

### Options that have Additional Charges:

- Add Down Seats & Backs

### Sleeper Options : (Sleepers not available at this time)

N/A



### Note:

All Dimensions are approximate, if accuracy is crucial, please contact us for validation of the dimensions shown. However, a 1" to 2" variance can still apply due to foam and upholstery.