

Standard / Armless

Put Green or Orange Arrows with Red or Tan Arrows to Create Sectional Groups

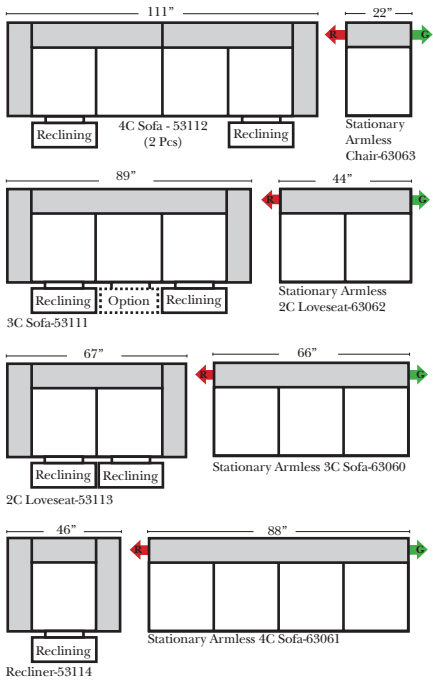

2-Piece Curve Sectional

Put Blue Arrows with Yellow Arrows to Create Sectional Groups or Green Arrows with Red Arrows to mix with some of the L-Shaped pieces.

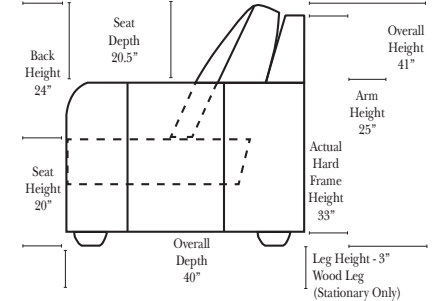
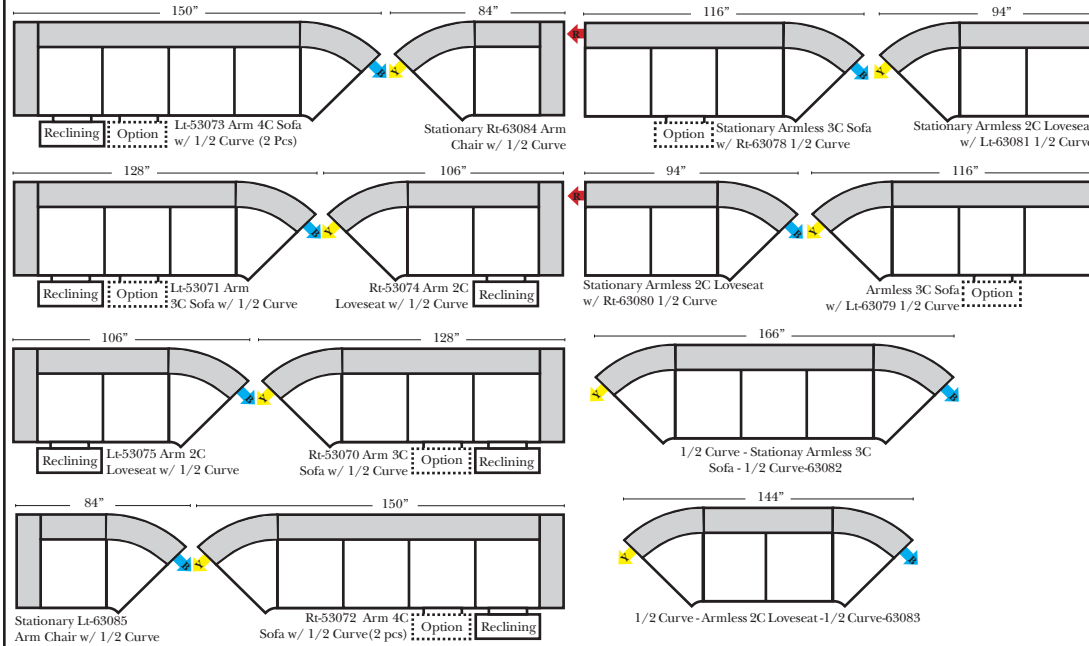

Standards & Options

Standard:

- Available in Full & Top Grain Leathers
- All Hardwood Frames
- Nail Heads
- Wood Leg Finish - Walnut Finish (Stationary Only)

Options: (No Additional Charge)

- No. 33 Firm Foam
- Wood Leg - Cherry, Chocolate, Espresso, Honey Oak, Shadow (Stationary Only)

Options: (Additional Charges Apply)

- Console Table - Standard as Espresso finish (N/C Option is Honey Oak finish)
- Metal Cup Holder (MCH) - Standard Finish is Silver (N/C Option is Black or Hammered Antique Finish)
- Electronic Cup Holder (ECH) (Console Arms Only) (Available with Motorized Reclining Seats only)
- Center Seat Recliner Option
- Motorized Recliner Mechanism
- Swivel Recliner Base (2 Arm Recliner Only)
- Swivel Glider Mechanism (2 Arm Recliner Only)
- Glider Mechanism Only (2 Arm Recliner Only)
- Lift Chair Dual Motor Mechanism (2 Arm Recliner Only)
- Upholstered Swivel Base (2 Arm Recliner Only)
- Motorized 180° Swivel Glider (2 Arm Recliner Only)

Sleeper Options: (Additional charges apply)

- Full Sleeper available w/Standard Mattress
- Deluxe Innerspring Mattress: Full
- Air Dream Coil Mattress: Full Only



Note:

All Dimensions are approximate, if accuracy is crucial, please contact us for validation of the dimensions shown. However, a 1" to 2" variance can still apply due to foam and upholstery.

All items on these pages are available as Stationary (Non-Reclining)

90 Degree / L-Shape Sectional

Put Green or Orange Arrows with Red or Tan Arrows to Create Sectional Groups

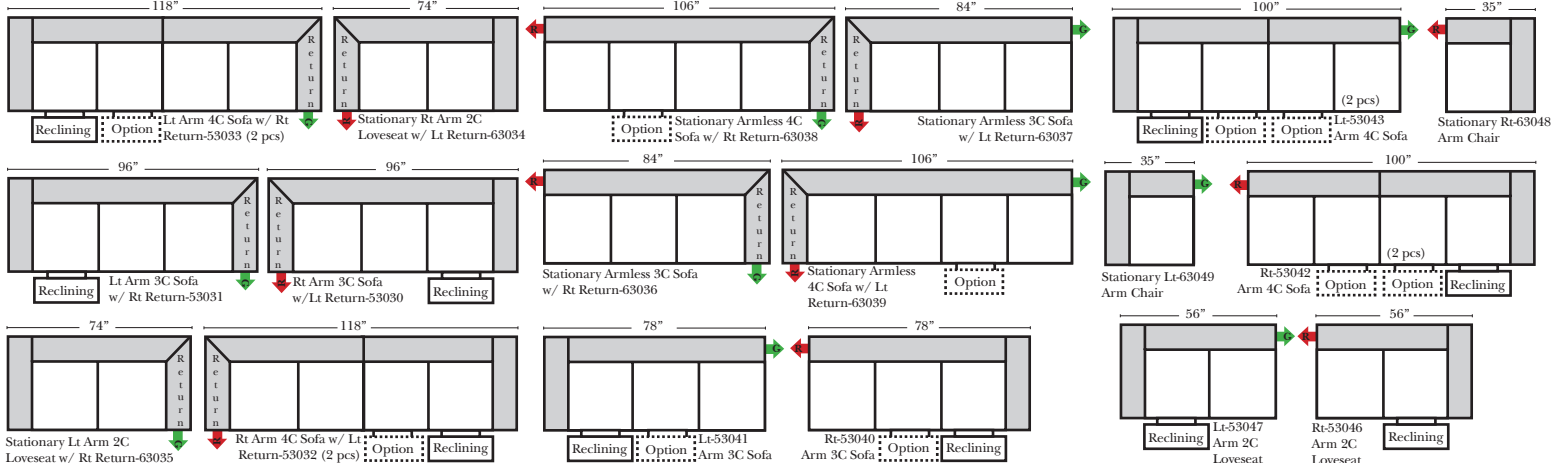

Bumper / Return Chaise & Conversation Sofas

Put Green Arrows with Red Arrows to Create Sectional Groups
Put Orange Arrows with Tan Arrows to Create Sectional Groups

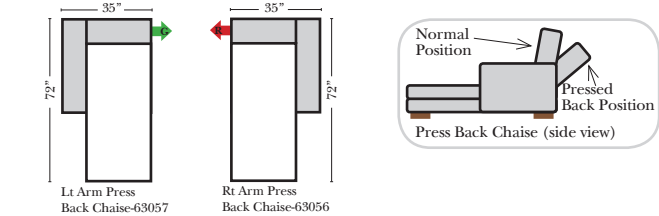

All Ottomans have a height of 19"

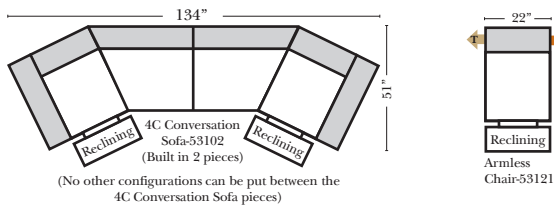
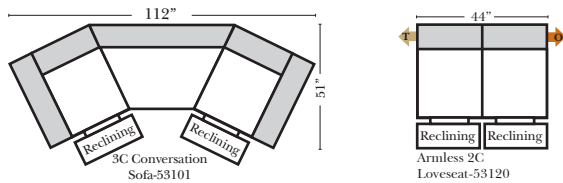
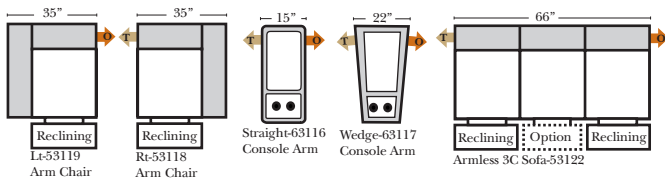
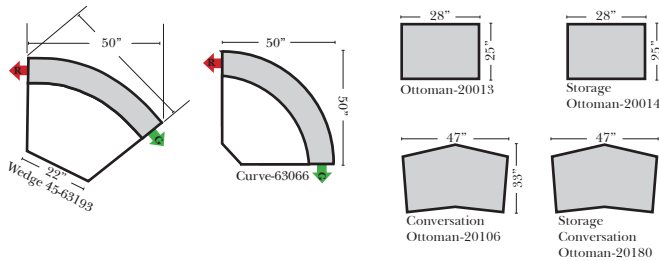

Sleepers

Put Blue Arrows with Yellow Arrows to Create Sectional Groups

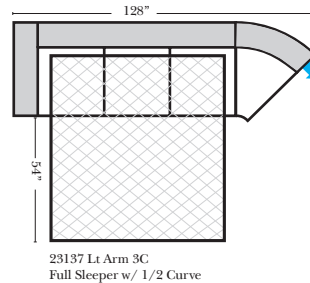
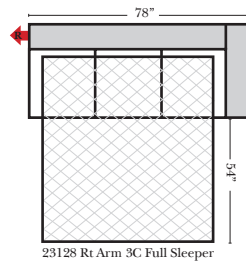
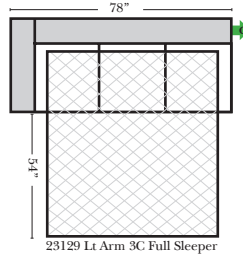
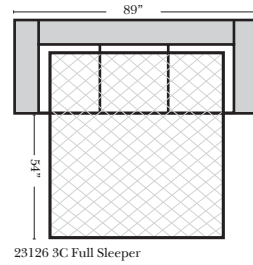

Suggested Configurations

v.11.23.15

The Suggested Configurations below are only a sample of what the imagination can create, please enjoy creating the configuration that fits your lifestyle, using the ideas below and from the items on the opposite page.

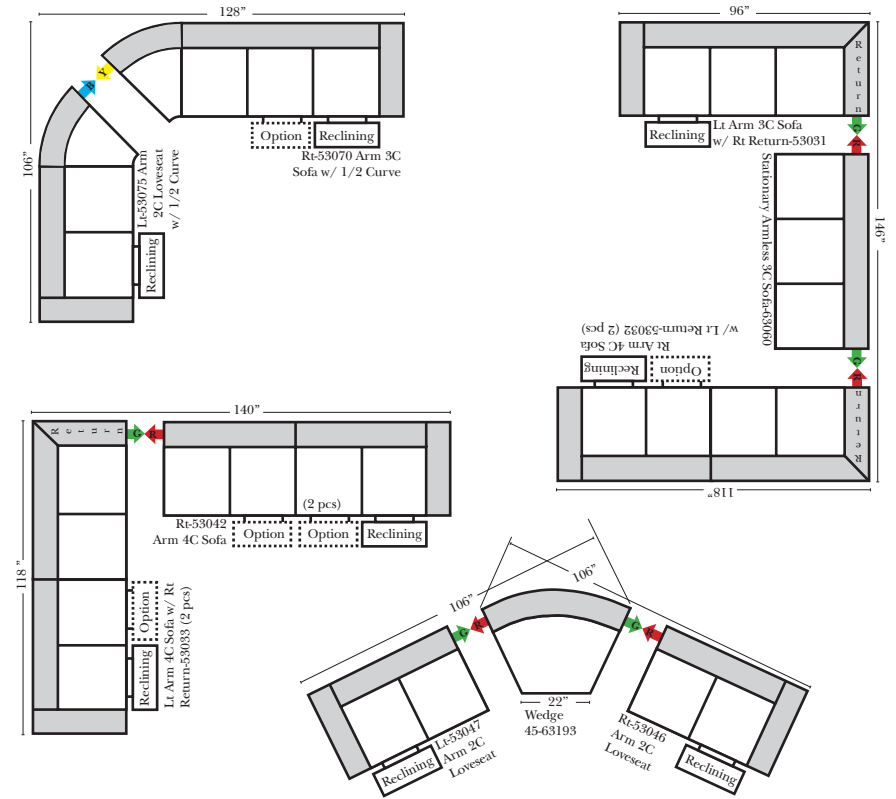

Sleepers (cont.)

